

frozy®

Buz Makineleri | *Ice Makers*

www.frozy.com.tr

2023





maximICE with frozy

Hakkımızda | About us

frozy



Eskişehir Organize Sanayi Bölgesi' nde 7.000 m² açık, 2.500 m² kapalı alan üzerinde kurulu modern tesislerimizde gastronomi ve ticari tip soğutucu & dondurucu ürünler üretilmektedir.

Büyük tecrübe ve bilgi birikimine sahip uzman personeli ile Pazar ihtiyaçlarından başlayarak, ürün tasarımı, üretim ve kalite süreçleri ile müşteriye kadar her adım profesyonel şekilde kurgulanmıştır. Akıllı, esnek üretim sistemi ve üstün kalite anlayışı ile fark yaratan bir işletme olarak faaliyet göstermektedir.

In our modern facilities established in Eskişehir Organized Industrial Site with 7.000m² open space and 2.500m² indoor area we produce commercial and gastronomy type coolers & freezers.

With expert staff that have great experience and knowledge, starting from market needs to product design, production and quality processes reaching the customer every step has been designed professionally. We are operating as a business that makes a difference with its intelligent and flexible production system as well as superior quality of understanding.







KULLANIM ALANLARI
USAGE AREAS



Özel Buz
Special Ice
Ice Code: SI
18 gr

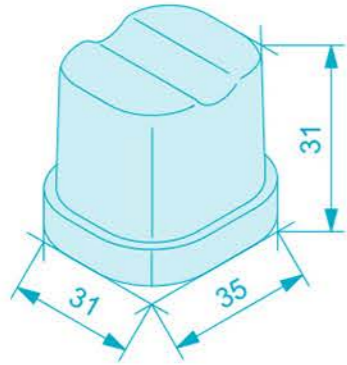

KULLANIM ALANLARI
USAGE AREAS

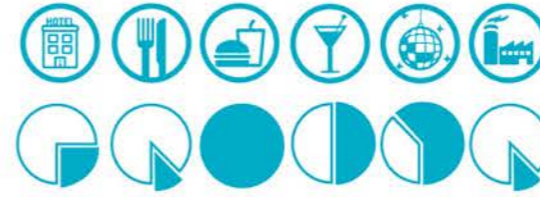

Tam Meşrubat Buzu
Full Dice Ice
Ice Code: FDI
12 gr

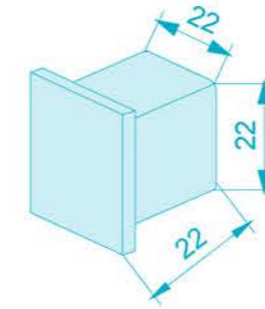

Yarım Meşrubat Buzu
Half Dice Ice
Ice Code: HDI
6 gr

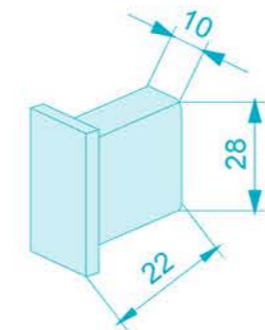

Findik Buz | Nugget Ice

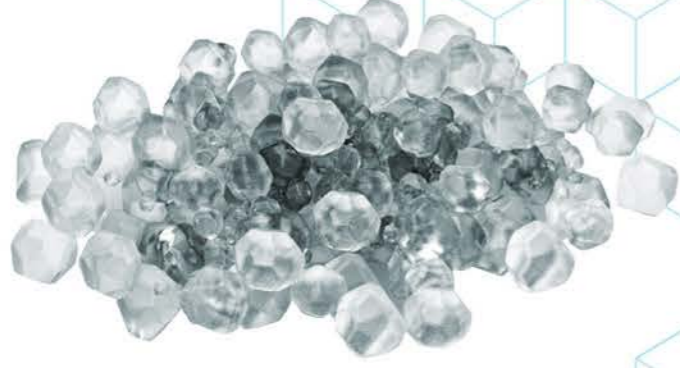

KULLANIM ALANLARI
USAGE AREAS



Findik Buz
Nugget Ice
Ice Code: NI

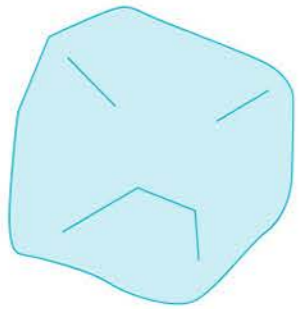

Kırık Buz | Flake Ice

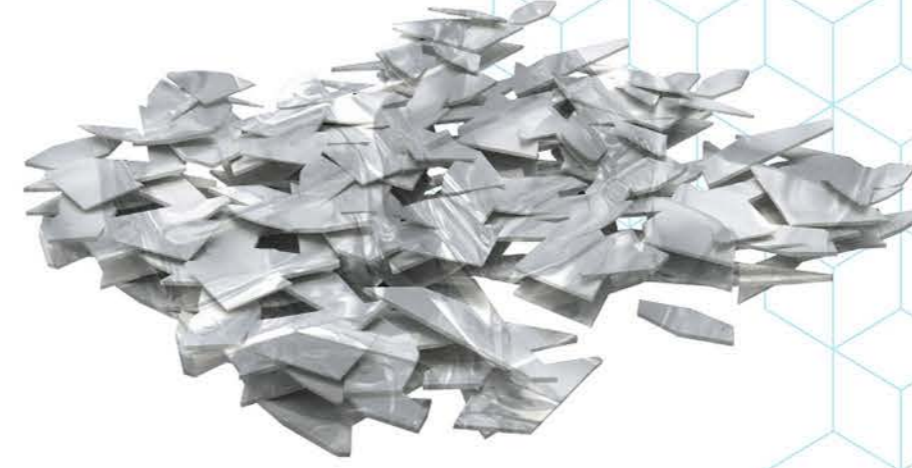

KULLANIM ALANLARI
USAGE AREAS



Kırık Buz
Flake Ice
Ice Code: FI

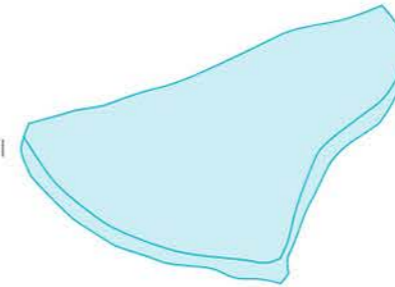

Oyuk Buz | Hollow Ice



KULLANIM ALANLARI
USAGE AREAS



Oyuk Buz
Special Ice
Ice Code: SI
18 gr

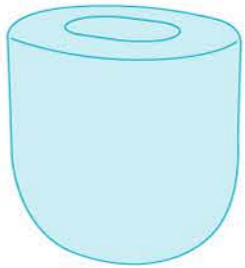

Hilal Buz | Cressent Ice

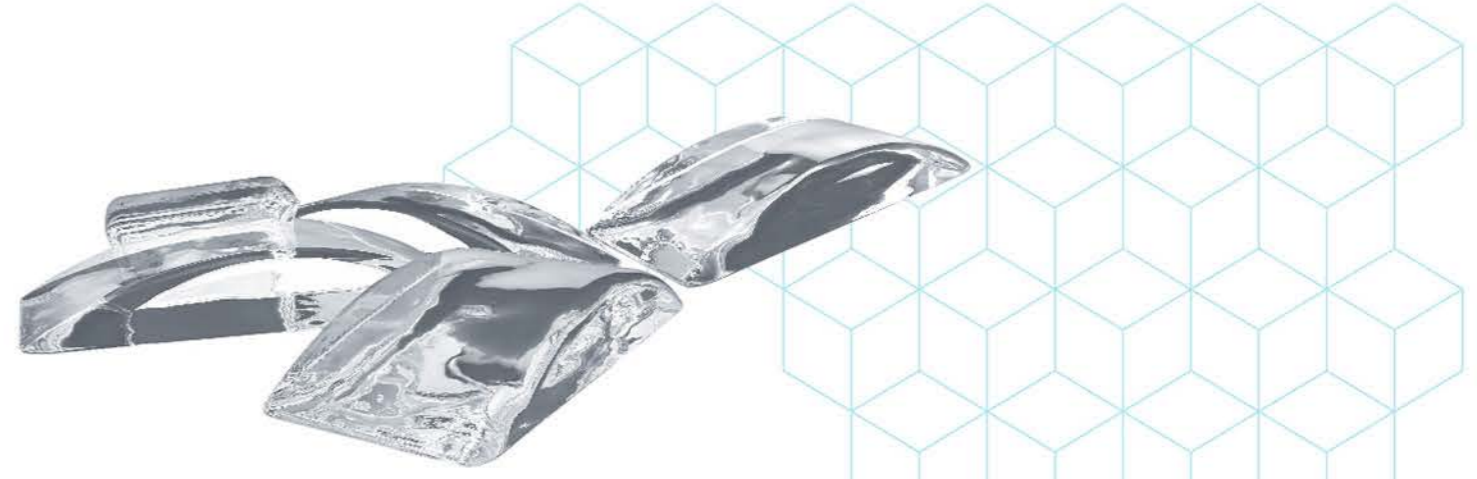

KULLANIM ALANLARI
USAGE AREAS

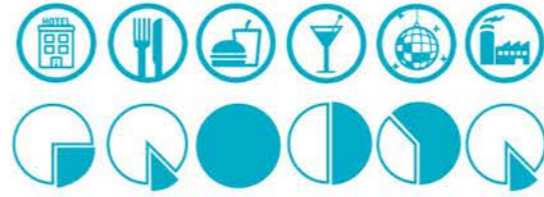

Oyuk Buz
Special Ice
Ice Code: SI
18 gr

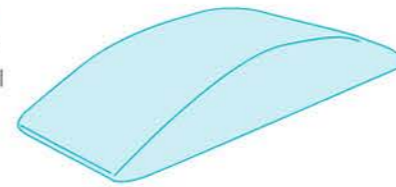



frozy

850 mm



All undercounter



frozy

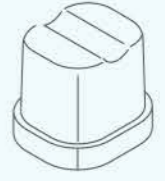

FR25

1.430 €

Soğutucu Gaz Refrigerant Gas	R404a	R290
Günlük Buz Yapma Kapasitesi (kg) Daily Production Capacity (kg)	22 kg	21 kg
Depolama Kapasitesi (kg) Storage Capacity (kg)	4 kg	4 kg
Buz Tipi Ice Type	Gurme Buz Gourmet Ice	Gurme Buz Gourmet Ice
Bir çevrimde buz miktarı (adet) Ice Capacity Per Cycle (unit)	18	18
Soğutma Sistemi Cooling System	Hava Air	Hava Air
İklim Sınıfı Climate Class	T	T
Voltaj Voltage	230-50/60 Hz 115-60 Hz	230-50 Hz 115-60 Hz
Maksimum Güç Maximum Power	400 W	300 W
Günlük Elektrik Tüketimi Daily Electric Consumption	6,7 kW	5,1 kW
Ürün Ağırlığı (kg) Product Weight (kg)	33 kg	33 kg
Ürün Ölçüleri (w*d*h) Product Dimension (w*d*h)	355*435*590	355*435*590
Ambalaj Ölçüleri (w*d*h) Packing Dimension (w*d*h)	411*490*770	411*490*770
Yükleme adedi (20 DC) Loading Quantities (20 DC)	210	210
Yükleme adedi (40 HC) Loading Quantities (40 HC)	420	420
Yükleme adedi (Optima Kamyon) Loading Quantities (Optima truck)	480	480



frozy

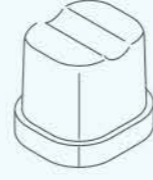

FR30

1.540 €

Soğutucu Gaz Refrigerant Gas	R404a	R290
Günlük Buz Yapma Kapasitesi (kg) Daily Production Capacity (kg)	27 kg	26 kg
Depolama Kapasitesi (kg) Storage Capacity (kg)	8 kg	8 kg
Buz Tipi Ice Type	Gurme Buz Gourmet Ice	Gurme Buz Gourmet Ice
Bir çevrimde buz miktarı (adet) Ice Capacity Per Cycle (unit)	18	18
Soğutma Sistemi Cooling System	Hava Air	Hava Air
İklim Sınıfı Climate Class	T	T
Voltaj Voltage	230-50/60 Hz 115-60 Hz	230-50 Hz 115-60 Hz
Maksimum Güç Maximum Power	450 W	350 W
Günlük Elektrik Tüketimi Daily Electric Consumption	7,5 kW	5,9 kW
Ürün Ağırlığı (kg) Product Weight (kg)	39 kg	39 kg
Ürün Ölçüleri (w*d*h) Product Dimension (w*d*h)	390*515*640	390*515*640
Ambalaj Ölçüleri (w*d*h) Packing Dimension (w*d*h)	446*581*815	446*581*815
Yükleme adedi (20 DC) Loading Quantities (20 DC)	168	168
Yükleme adedi (40 HC) Loading Quantities (40 HC)	368	368
Yükleme adedi (Optima Kamyon) Loading Quantities (Optima truck)	405	405



frozy

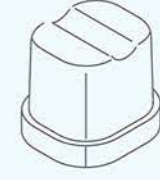

FR35

1.750 €

Soğutucu Gaz Refrigerant Gas	R404a	R290
Günlük Buz Yapma Kapasitesi (kg) Daily Production Capacity (kg)	32 kg	33 kg
Depolama Kapasitesi (kg) Storage Capacity (kg)	16 kg	16 kg
Buz Tipi Ice Type	Gurme Buz Gourmet Ice	Gurme Buz Gourmet Ice
Bir çevrimde buz miktarı (adet) Ice Capacity Per Cycle (unit)	28	28
Soğutma Sistemi Cooling System	Hava Air	Hava Air
İklim Sınıfı Climate Class	T	T
Voltaj Voltage	230-50/60 Hz 115-60 Hz	230-50 Hz 115-60 Hz
Maksimum Güç Maximum Power	500 W	470 W
Günlük Elektrik Tüketimi Daily Electric Consumption	9,0 kW	8,5 kW
Ürün Ağırlığı (kg) Product Weight (kg)	48 kg	48 kg
Ürün Ölçüleri (w*d*h) Product Dimension (w*d*h)	500*580*690	500*580*690
Ambalaj Ölçüleri (w*d*h) Packing Dimension (w*d*h)	560*640*855	560*640*855
Yükleme adedi (20 DC) Loading Quantities (20 DC)	72	72
Yükleme adedi (40 HC) Loading Quantities (40 HC)	216	216
Yükleme adedi (Optima Kamyon) Loading Quantities (Optima truck)	279	279



frozy



FR40

1.850 €

Soğutucu Gaz Refrigerant Gas	R404a	R290
Günlük Buz Yapma Kapasitesi (kg) Daily Production Capacity (kg)	40 kg	37 kg
Depolama Kapasitesi (kg) Storage Capacity (kg)	16 kg	16 kg
Buz Tipi Ice Type	Gurme Buz Gourmet Ice	Gurme Buz Gourmet Ice
Bir çevrimde buz miktarı (adet) Ice Capacity Per Cycle (unit)	36	36
Soğutma Sistemi Cooling System	Hava Air	Hava Air
İklim Sınıfı Climate Class	T	T
Voltaj Voltage	230-50/60 Hz 115-60 Hz	230-50 Hz 115-60 Hz
Maksimum Güç Maximum Power	550 W	520 W
Günlük Elektrik Tüketimi Daily Electric Consumption	11,0 kW	10,4 kW
Ürün Ağırlığı (kg) Product Weight (kg)	48 kg	48 kg
Ürün Ölçüleri (w*d*h) Product Dimension (w*d*h)	500*580*690	500*580*690
Ambalaj Ölçüleri (w*d*h) Packing Dimension (w*d*h)	560*640*855	560*640*855
Yükleme adedi (20 DC) Loading Quantities (20 DC)	72	72
Yükleme adedi (40 HC) Loading Quantities (40 HC)	216	216
Yükleme adedi (Optima Kamyon) Loading Quantities (Optima truck)	279	279



frozy

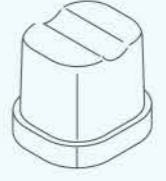

FR50

2.100 €

Soğutucu Gaz Refrigerant Gas	R404a	R290
Günlük Buz Yapma Kapasitesi (kg) Daily Production Capacity (kg)	47 kg	47 kg
Depolama Kapasitesi (kg) Storage Capacity (kg)	28 kg	28 kg
Buz Tipi Ice Type	Gurme Buz Gourmet Ice	Gurme Buz Gourmet Ice
Bir çevrimde buz miktarı (adet) Ice Capacity Per Cycle (unit)	44	44
Soğutma Sistemi Cooling System	Hava Air	Hava Air
İklim Sınıfı Climate Class	T	T
Voltaj Voltage	230-50/60 Hz 115-60 Hz	230-50 Hz 115-60 Hz
Maksimum Güç Maximum Power	600 W	550 W
Günlük Elektrik Tüketimi Daily Electric Consumption	13,7 kW	12,6 kW
Ürün Ağırlığı (kg) Product Weight (kg)	53 kg	53 kg
Ürün Ölçüleri (w*d*h) Product Dimension (w*d*h)	500*580*800	500*580*800
Ambalaj Ölçüleri (w*d*h) Packing Dimension (w*d*h)	560*640*965	560*640*965
Yükleme adedi (20 DC) Loading Quantities (20 DC)	72	72
Yükleme adedi (40 HC) Loading Quantities (40 HC)	144	144
Yükleme adedi (Optima Kamyon) Loading Quantities (Optima truck)	186	186



frozy

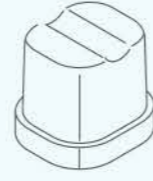

FR60

2.300 €

Soğutucu Gaz Refrigerant Gas	R404a	R290
Günlük Buz Yapma Kapasitesi (kg) Daily Production Capacity (kg)	57 kg	57 kg
Depolama Kapasitesi (kg) Storage Capacity (kg)	28 kg	28 kg
Buz Tipi Ice Type	Gurme Buz Gourmet Ice	Gurme Buz Gourmet Ice
Bir çevrimde buz miktarı (adet) Ice Capacity Per Cycle (unit)	44	44
Soğutma Sistemi Cooling System	Hava Air	Hava Air
İklim Sınıfı Climate Class	T	T
Voltaj Voltage	230-50/60 Hz 115-60 Hz	230-50 Hz 115-60 Hz
Maksimum Güç Maximum Power	600 W	550 W
Günlük Elektrik Tüketimi Daily Electric Consumption	14,9 kW	14,7 kW
Ürün Ağırlığı (kg) Product Weight (kg)	56 kg	56 kg
Ürün Ölçüleri (w*d*h) Product Dimension (w*d*h)	500*580*800	500*580*800
Ambalaj Ölçüleri (w*d*h) Packing Dimension (w*d*h)	560*640*965	560*640*965
Yükleme adedi (20 DC) Loading Quantities (20 DC)	72	72
Yükleme adedi (40 HC) Loading Quantities (40 HC)	144	144
Yükleme adedi (Optima Kamyon) Loading Quantities (Optima truck)	186	186



frozy

eco friendly



R290
Natural Refrigerant

frozy

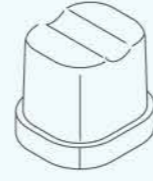

FR70

2.700 €

Soğutucu Gaz Refrigerant Gas	R404a	R290
Günlük Buz Yapma Kapasitesi (kg) Daily Production Capacity (kg)	67 kg	66 kg
Depolama Kapasitesi (kg) Storage Capacity (kg)	40 kg	40 kg
Buz Tipi Ice Type	Gurme Buz Gourmet Ice	Gurme Buz Gourmet Ice
Bir çevrimde buz miktarı (adet) Ice Capacity Per Cycle (unit)	60	60
Soğutma Sistemi Cooling System	Hava Air	Hava Air
İklim Sınıfı Climate Class	T	T
Voltaj Voltage	230-50/60 Hz 115-60 Hz	230-50 Hz 115-60 Hz
Maksimum Güç Maximum Power	800 W	780 W
Günlük Elektrik Tüketimi Daily Electric Consumption	16,5 kW	16,1 kW
Ürün Ağırlığı (kg) Product Weight (kg)	81 kg	81 kg
Ürün Ölçüleri (w*d*h) Product Dimension (w*d*h)	738*600*822	738*600*822
Ambalaj Ölçüleri (w*d*h) Packing Dimension (w*d*h)	800*670*995	800*670*995
Yükleme adedi (20 DC) Loading Quantities (20 DC)	46	46
Yükleme adedi (40 HC) Loading Quantities (40 HC)	102	102
Yükleme adedi (Optima Kamyon) Loading Quantities (Optima truck)	120	120



frozy

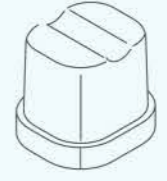

FR90

3.000 €

Soğutucu Gaz Refrigerant Gas	R404a	R290
Günlük Buz Yapma Kapasitesi (kg) Daily Production Capacity (kg)	85 kg	85 kg
Depolama Kapasitesi (kg) Storage Capacity (kg)	40 kg	40 kg
Buz Tipi Ice Type	Gurme Buz Gourmet Ice	Gurme Buz Gourmet Ice
Bir çevrimde buz miktarı (adet) Ice Capacity Per Cycle (unit)	60	60
Soğutma Sistemi Cooling System	Hava Air	Hava Air
İklim Sınıfı Climate Class	T	T
Voltaj Voltage	230-50/60 Hz 115-60 Hz	230-50 Hz 115-60 Hz
Maksimum Güç Maximum Power	1.100 W	1.000 W
Günlük Elektrik Tüketimi Daily Electric Consumption	18,0 kW	16,4 kW
Ürün Ağırlığı (kg) Product Weight (kg)	94 kg	94 kg
Ürün Ölçüleri (w*d*h) Product Dimension (w*d*h)	738*600*822	738*600*822
Ambalaj Ölçüleri (w*d*h) Packing Dimension (w*d*h)	800*670*995	800*670*995
Yükleme adedi (20 DC) Loading Quantities (20 DC)	46	46
Yükleme adedi (40 HC) Loading Quantities (40 HC)	102	102
Yükleme adedi (Optima Kamyon) Loading Quantities (Optima truck)	120	120



frozy



FR100

3.200 €

Soğutucu Gaz Refrigerant Gas	R404a	R290
Günlük Buz Yapma Kapasitesi (kg) Daily Production Capacity (kg)	96 kg	96 kg
Depolama Kapasitesi (kg) Storage Capacity (kg)	40 kg	40 kg
Buz Tipi Ice Type	Gurme Buz Gourmet Ice	Gurme Buz Gourmet Ice
Bir çevrimde buz miktarı (adet) Ice Capacity Per Cycle (unit)	68	68
Soğutma Sistemi Cooling System	Hava Air	Hava Air
İklim Sınıfı Climate Class	T	T
Voltaaj Voltage	230-50/60 Hz 115-60 Hz	230-50/60 Hz 115-60 Hz
Maksimum Güç Maximum Power	1.200 W	1.100 W
Günlük Elektrik Tüketimi Daily Electric Consumption	18,0 kW	17 kW
Ürün Ağırlığı (kg) Product Weight (kg)	97 kg	97 kg
Ürün Ölçüleri (w*d*h) Product Dimension (w*d*h)	738*600*822	738*600*822
Ambalaj Ölçüleri (w*d*h) Packing Dimension (w*d*h)	800*670*995	800*670*995
Yükleme adedi (20 DC) Loading Quantities (20 DC)	46	46
Yükleme adedi (40 HC) Loading Quantities (40 HC)	102	102
Yükleme adedi (Optima Kamyon) Loading Quantities (Optima truck)	120	120



frozy

modular series



frozy

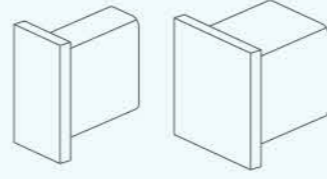

FR250

5.200 €

Soğutucu Gaz Refrigerant Gas	R404a	R452a
Günlük Buz Yapma Kapasitesi (kg) Daily Production Capacity (kg)	230 kg	230 kg
Buz Tipi Ice Type	Tam Meşrubat Buzu Full Dice Ice	
Bir çevrimde buz miktarı (adet) Ice Capacity Per Cycle (unit)	260	260
Soğutma Sistemi Cooling System	Hava Air	Hava Air
İklim Sınıfı Climate Class	T	T
Voltaj Voltage	230 - 50/60 Hz 115 - 60 Hz	230 - 50/60 Hz 115 - 60 Hz
Maksimum Güç Maximum Power	1.200 W	1.150 W
Günlük Elektrik Tüketimi Daily Electric Consumption	28 kW	27.0 kW
Ürün Ağırlığı (kg) Product Weight (kg)	85 kg	85 kg
Ürün Ölçüleri (w*d*h) Product Dimension (w*d*h)	761*622*576	761*622*576
Ambalaj Ölçüleri (w*d*h) Packing Dimension (w*d*h)	830*690*760	830*690*760
Yükleme adedi (20 DC) Loading Quantities (20 DC)	69	69
Yükleme adedi (40 HC) Loading Quantities (40 HC)	144	144
Yükleme adedi (Optima Kamyon) Loading Quantities (Optima truck)	192	192



frozy

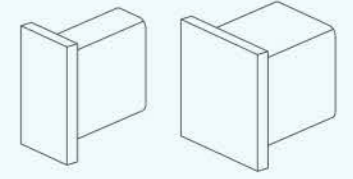

FR500

6.300 €

Soğutucu Gaz Refrigerant Gas	R404a	R452a
Günlük Buz Yapma Kapasitesi (kg) Daily Production Capacity (kg)	450 kg	450 kg
Buz Tipi Ice Type	Tam Meşrubat Buzu Full Dice Ice	
Bir çevrimde buz miktarı (adet) Ice Capacity Per Cycle (unit)	440	440
Soğutma Sistemi Cooling System	Hava Air	Hava Air
İklim Sınıfı Climate Class	T	T
Voltaj Voltage	230 - 50/60 Hz 115 - 60 Hz	230 - 50/60 Hz 115 - 60 Hz
Maksimum Güç Maximum Power	2.500 W	2.400 W
Günlük Elektrik Tüketimi Daily Electric Consumption	61,5 kW	59,5 kW
Ürün Ağırlığı (kg) Product Weight (kg)	113 kg	113 kg
Ürün Ölçüleri (w*d*h) Product Dimension (w*d*h)	761*622*726	761*622*726
Ambalaj Ölçüleri (w*d*h) Packing Dimension (w*d*h)	830*690*960	830*690*960
Yükleme adedi (20 DC) Loading Quantities (20 DC)	69	69
Yükleme adedi (40 HC) Loading Quantities (40 HC)	144	144
Yükleme adedi (Optima Kamyon) Loading Quantities (Optima truck)	162	162



frozy

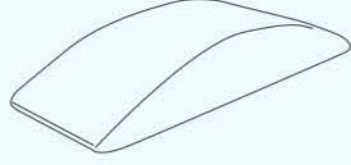

FR350

5.900 €

Soğutucu Gaz Refrigerant Gas	R404a	R452a
Günlük Buz Yapma Kapasitesi (kg) Daily Production Capacity (kg)	275 kg	275
Buz Tipi Ice Type	Yarım Silindir Buz Crescent Ice	
Bir çevrimde buz miktarı Ice Capacity Per Cycle	392	392
Soğutma Sistemi Cooling System	Hava Air	Hava Air
İklim Sınıfı Climate Class	T	T
Voltaj Voltage	230 - 50 Hz 115 - 60 Hz	230 - 50 Hz 115 - 60 Hz
Maksimum Güç Maximum Power	2.500 W	2.400 W
Günlük Elektrik Tüketimi Daily Electric Consumption	61.5 kW	59.5 kW
Ürün Ağırlığı (kg) Product Weight (kg)	120 kg	120 kg
Ürün Ölçüleri (w*d*h) Product Dimension (w*d*h)	761*622*826	761*622*826
Ambalaj Ölçüleri (w*d*h) Packing Dimension (w*d*h)	830*690*960	830*690*960
Yükleme adedi (20 DC) Loading Quantities (20 DC)	69	69
Yükleme adedi (40 HC) Loading Quantities (40 HC)	144	144
Yükleme adedi (Optima Kamyon) Loading Quantities (Optima truck)	162	162



SB 200

1.850 €

Kapsite (kg) Capacity (kg)	175 kg
Ağırlık (kg) Weight (kg)	62 kg
Hacim (m ³) Volume (m ³)	0,35
Uyumlu Buz Makineleri Usable Ice Makers	FR250, FR500
Ürün Ölçüleri (w*d*h) Product Dimension (w*d*h)	765*842*1002
Ambalaj Ölçüleri (w*d*h) Packing Dimension (w*d*h)	840*960*1040
Yükleme adedi (20 DC) Loading Quantities (20 DC)	28
Yükleme adedi (40 HC) Loading Quantities (40 HC)	56
Yükleme adedi (Optima Kamyon) Loading Quantities (Optima truck)	96

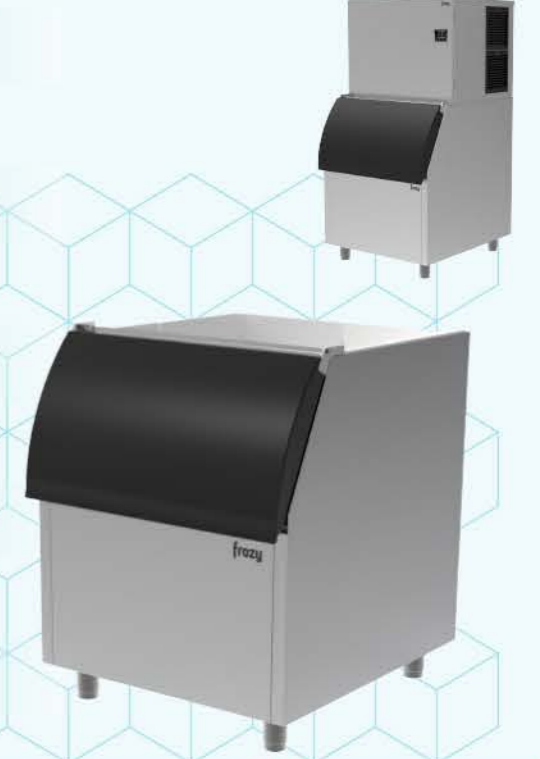

SB 400

2.050 €

Kapsite (kg) Capacity (kg)	210 kg
Ağırlık (kg) Weight (kg)	70 kg
Hacim (m ³) Volume (m ³)	0,42
Uyumlu Buz Makineleri Usable Ice Makers	FR250, FR500
Ürün Ölçüleri (w*d*h) Product Dimension (w*d*h)	765*842*1150
Ambalaj Ölçüleri (w*d*h) Packing Dimension (w*d*h)	840*960*1190
Yükleme adedi (20 DC) Loading Quantities (20 DC)	28
Yükleme adedi (40 HC) Loading Quantities (40 HC)	56
Yükleme adedi (Optima Kamyon) Loading Quantities (Optima truck)	96





frozy



**Built-in series
with front ventilation**



frozy

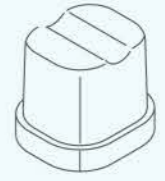

FR35U

1.900 €

Soğutucu Gaz Refrigerant Gas	R404a	R290
Günlük Buz Yapma Kapasitesi (kg) Daily Production Capacity (kg)	32 kg	33 kg
Depolama Kapasitesi (kg) Storage Capacity (kg)	16 kg	16 kg
Buz Tipi Ice Type	Özel Buz Special Ice	Özel Buz Special Ice
Bir çevrimde buz miktarı (adet) Ice Capacity Per Cycle (unit)	28	28
Soğutma Sistemi Cooling System	Hava Air	Hava Air
İklim Sınıfı Climate Class	T	T
Voltaj Voltage	230-50/60 Hz 115-60 Hz	230-50 Hz 115-60 Hz
Maksimum Güç Maximum Power	535 W	510 W
Günlük Elektrik Tüketimi Daily Electric Consumption	9,7 kW	9,1 kW
Ürün Ağırlığı (kg) Product Weight (kg)	51 kg	51 kg
Ürün Ölçüleri (w*d*h) Product Dimension (w*d*h)	500*580*690	500*580*690
Ambalaj Ölçüleri (w*d*h) Packing Dimension (w*d*h)	560*640*855	560*640*855
Yükleme adedi (20 DC) Loading Quantities (20 DC)	72	72
Yükleme adedi (40 HC) Loading Quantities (40 HC)	216	216
Yükleme adedi (Optima Kamyon) Loading Quantities (Optima truck)	279	279



frozy

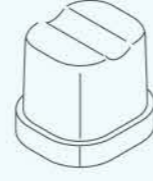

FR40U

2.000 €

Soğutucu Gaz Refrigerant Gas	R404a	R290
Günlük Buz Yapma Kapasitesi (kg) Daily Production Capacity (kg)	40 kg	37 kg
Depolama Kapasitesi (kg) Storage Capacity (kg)	16 kg	16 kg
Buz Tipi Ice Type	Özel Buz Special Ice	Özel Buz Special Ice
Bir çevrimde buz miktarı (adet) Ice Capacity Per Cycle (unit)	36	36
Soğutma Sistemi Cooling System	Hava Air	Hava Air
İklim Sınıfı Climate Class	T	T
Voltaj Voltage	230-50/60 Hz 115-60 Hz	230-50 Hz 115-60 Hz
Maksimum Güç Maximum Power	590 W	560 W
Günlük Elektrik Tüketimi Daily Electric Consumption	11,8 kW	11,2 kW
Ürün Ağırlığı (kg) Product Weight (kg)	51 kg	51 kg
Ürün Ölçüleri (w*d*h) Product Dimension (w*d*h)	500*580*690	500*580*690
Ambalaj Ölçüleri (w*d*h) Packing Dimension (w*d*h)	560*640*855	560*640*855
Yükleme adedi (20 DC) Loading Quantities (20 DC)	72	72
Yükleme adedi (40 HC) Loading Quantities (40 HC)	216	216
Yükleme adedi (Optima Kamyon) Loading Quantities (Optima truck)	279	279



frozy

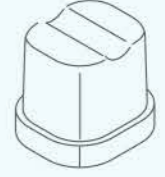

FR50U

2.250 €

Soğutucu Gaz Refrigerant Gas	R404a	R290
Günlük Buz Yapma Kapasitesi (kg) Daily Production Capacity (kg)	47 kg	47 kg
Depolama Kapasitesi (kg) Storage Capacity (kg)	28 kg	28 kg
Buz Tipi Ice Type	Özel Buz Special Ice	Özel Buz Special Ice
Bir çevrimde buz miktarı (adet) Ice Capacity Per Cycle (unit)	44	44
Soğutma Sistemi Cooling System	Hava Air	Hava Air
İklim Sınıfı Climate Class	T	T
Voltaj Voltage	230-50/60 Hz 115-60 Hz	230-50 Hz 115-60 Hz
Maksimum Güç Maximum Power	650 W	590 W
Günlük Elektrik Tüketimi Daily Electric Consumption	14,7 kW	13,5 kW
Ürün Ağırlığı (kg) Product Weight (kg)	56 kg	56 kg
Ürün Ölçüleri (w*d*h) Product Dimension (w*d*h)	500*580*800	500*580*800
Ambalaj Ölçüleri (w*d*h) Packing Dimension (w*d*h)	560*640*965	560*640*965
Yükleme adedi (20 DC) Loading Quantities (20 DC)	72	72
Yükleme adedi (40 HC) Loading Quantities (40 HC)	144	144
Yükleme adedi (Optima Kamyon) Loading Quantities (Optima truck)	186	186



frozy

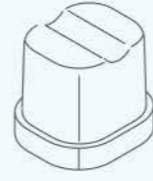

FR60U

2.450 €

Soğutucu Gaz Refrigerant Gas	R404a	R290
Günlük Buz Yapma Kapasitesi (kg) Daily Production Capacity (kg)	57 kg	57 kg
Depolama Kapasitesi (kg) Storage Capacity (kg)	40 kg	40 kg
Buz Tipi Ice Type	Özel Buz Special Ice	Özel Buz Special Ice
Bir çevrimde buz miktarı (adet) Ice Capacity Per Cycle (unit)	44	44
Soğutma Sistemi Cooling System	Hava Air	Hava Air
İklim Sınıfı Climate Class	T	T
Voltaj Voltage	230-50/60 Hz 115-60 Hz	230-50 Hz 115-60 Hz
Maksimum Güç Maximum Power	650 W	590 W
Günlük Elektrik Tüketimi Daily Electric Consumption	15,9 kW	15,6 kW
Ürün Ağırlığı (kg) Product Weight (kg)	59 kg	59 kg
Ürün Ölçüleri (w*d*h) Product Dimension (w*d*h)	500*580*800	500*580*800
Ambalaj Ölçüleri (w*d*h) Packing Dimension (w*d*h)	560*640*965	560*640*965
Yükleme adedi (20 DC) Loading Quantities (20 DC)	72	72
Yükleme adedi (40 HC) Loading Quantities (40 HC)	144	144
Yükleme adedi (Optima Kamyon) Loading Quantities (Optima truck)	186	186



frozy

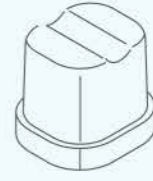

FR70U

2.850 €

Soğutucu Gaz Refrigerant Gas	R404a	R290
Günlük Buz Yapma Kapasitesi (kg) Daily Production Capacity (kg)	67 kg	66 kg
Depolama Kapasitesi (kg) Storage Capacity (kg)	40 kg	40 kg
Buz Tipi Ice Type	Özel Buz Special Ice	Özel Buz Special Ice
Bir çevrimde buz miktarı (adet) Ice Capacity Per Cycle (unit)	60	60
Soğutma Sistemi Cooling System	Hava Air	Hava Air
İklim Sınıfı Climate Class	T	T
Voltaj Voltage	230-50/60 Hz 115-60 Hz	230-50 Hz 115-60 Hz
Maksimum Güç Maximum Power	860 W	840 W
Günlük Elektrik Tüketimi Daily Electric Consumption	17,7 kW	17,3 kW
Ürün Ağırlığı (kg) Product Weight (kg)	85 kg	85 kg
Ürün Ölçüleri (w*d*h) Product Dimension (w*d*h)	738*600*822	738*600*822
Ambalaj Ölçüleri (w*d*h) Packing Dimension (w*d*h)	800*670*995	800*670*995
Yükleme adedi (20 DC) Loading Quantities (20 DC)	46	46
Yükleme adedi (40 HC) Loading Quantities (40 HC)	102	102
Yükleme adedi (Optima Kamyon) Loading Quantities (Optima truck)	120	120



frozy

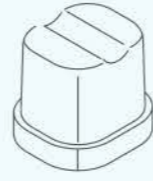

FR90U

3.150 €

Soğutucu Gaz Refrigerant Gas	R404a	R290
Günlük Buz Yapma Kapasitesi (kg) Daily Production Capacity (kg)	85 kg	85 kg
Depolama Kapasitesi (kg) Storage Capacity (kg)	40 kg	40 kg
Buz Tipi Ice Type	Özel Buz Special Ice	Özel Buz Special Ice
Bir çevrimde buz miktarı (adet) Ice Capacity Per Cycle (unit)	60	60
Soğutma Sistemi Cooling System	Hava Air	Hava Air
İklim Sınıfı Climate Class	T	T
Voltaj Voltage	230-50/60 Hz 115-60 Hz	230-50 Hz 115-60 Hz
Maksimum Güç Maximum Power	1.180 W	1.070 W
Günlük Elektrik Tüketimi Daily Electric Consumption	19,3 kW	17,6 kW
Ürün Ağırlığı (kg) Product Weight (kg)	98 kg	98 kg
Ürün Ölçüleri (w*d*h) Product Dimension (w*d*h)	738*600*822	738*600*822
Ambalaj Ölçüleri (w*d*h) Packing Dimension (w*d*h)	800*670*995	800*670*995
Yükleme adedi (20 DC) Loading Quantities (20 DC)	46	46
Yükleme adedi (40 HC) Loading Quantities (40 HC)	102	102
Yükleme adedi (Optima Kamyon) Loading Quantities (Optima truck)	120	120



frozy



FR41

1.950 €

Soğutucu Gaz Refrigerant Gas	R404a	R290
Günlük Buz Yapma Kapasitesi (kg) Daily Production Capacity (kg)	35 kg	35 kg
Depolama Kapasitesi (kg) Storage Capacity (kg)	16 kg	16 kg
Buz Tipi Ice Type	Silindir Buz Hallow Ice	Silindir Buz Hallow Ice
Bir çevrimde buz miktarı (adet) Ice Capacity Per Cycle (unit)	24	24
Soğutma Sistemi Cooling System	Hava Air	Hava Air
İklim Sınıfı Climate Class	T	T
Voltaj Voltage	230-50/60 Hz 115-60 Hz	230-50 Hz 115-60 Hz
Maksimum Güç Maximum Power	550 W	420 W
Günlük Elektrik Tüketimi Daily Electric Consumption	11,0 kW	7,8 kW
Ürün Ağırlığı (kg) Product Weight (kg)	50 kg	50 kg
Ürün Ölçüleri (w*d*h) Product Dimension (w*d*h)	500*580*690	500*580*690
Ambalaj Ölçüleri (w*d*h) Packing Dimension (w*d*h)	560*640*855	560*640*855
Yükleme adedi (20 DC) Loading Quantities (20 DC)	72	72
Yükleme adedi (40 HC) Loading Quantities (40 HC)	216	216
Yükleme adedi (Optima Kamyon) Loading Quantities (Optima truck)	279	279



frozy



FR51

2.100 €

Soğutucu Gaz Refrigerant Gas	R404a	R290
Günlük Buz Yapma Kapasitesi (kg) Daily Production Capacity (kg)	45 kg	45 kg
Depolama Kapasitesi (kg) Storage Capacity (kg)	16 kg	16 kg
Buz Tipi Ice Type	Silindir Buz Hallow Ice	Silindir Buz Hallow Ice
Bir çevrimde buz miktarı (adet) Ice Capacity Per Cycle (unit)	32	32
Soğutma Sistemi Cooling System	Hava Air	Hava Air
İklim Sınıfı Climate Class	T	T
Voltaj Voltage	230-50/60 Hz 115-60 Hz	230-50 Hz 115-60 Hz
Maksimum Güç Maximum Power	600 W	480 W
Günlük Elektrik Tüketimi Daily Electric Consumption	13,7 kW	9,1 kW
Ürün Ağırlığı (kg) Product Weight (kg)	50 kg	50 kg
Ürün Ölçüleri (w*d*h) Product Dimension (w*d*h)	500*580*690	500*580*690
Ambalaj Ölçüleri (w*d*h) Packing Dimension (w*d*h)	560*640*855	560*640*855
Yükleme adedi (20 DC) Loading Quantities (20 DC)	72	72
Yükleme adedi (40 HC) Loading Quantities (40 HC)	216	216
Yükleme adedi (Optima Kamyon) Loading Quantities (Optima truck)	279	279



frozy



FR61

2.300 €

Soğutucu Gaz Refrigerant Gas	R404a	R290
Günlük Buz Yapma Kapasitesi (kg) Daily Production Capacity (kg)	57 kg	57 kg
Depolama Kapasitesi (kg) Storage Capacity (kg)	28 kg	28 kg
Buz Tipi Ice Type	Silindir Buz Hallow Ice	Silindir Buz Hallow Ice
Bir çevrimde buz miktarı (adet) Ice Capacity Per Cycle (unit)	40	40
Soğutma Sistemi Cooling System	Hava Air	Hava Air
İklim Sınıfı Climate Class	T	T
Voltaj Voltage	230-50/60 Hz 115-60 Hz	230-50 Hz 115-60 Hz
Maksimum Güç Maximum Power	600 W	510 W
Günlük Elektrik Tüketimi Daily Electric Consumption	14,9 kW	11,2 kW
Ürün Ağırlığı (kg) Product Weight (kg)	55 kg	55 kg
Ürün Ölçüleri (w*d*h) Product Dimension (w*d*h)	500*580*800	500*580*800
Ambalaj Ölçüleri (w*d*h) Packing Dimension (w*d*h)	560*640*965	560*640*965
Yükleme adedi (20 DC) Loading Quantities (20 DC)	72	72
Yükleme adedi (40 HC) Loading Quantities (40 HC)	144	144
Yükleme adedi (Optima Kamyon) Loading Quantities (Optima truck)	186	186



frozy



FR71

2.800 €

Soğutucu Gaz Refrigerant Gas	R404a	R290
Günlük Buz Yapma Kapasitesi (kg) Daily Production Capacity (kg)	68 kg	68 kg
Depolama Kapasitesi (kg) Storage Capacity (kg)	28 kg	28 kg
Buz Tipi Ice Type	Silindir Buz Hallow Ice	Silindir Buz Hallow Ice
Bir çevrimde buz miktarı (adet) Ice Capacity Per Cycle (unit)	48	48
Soğutma Sistemi Cooling System	Hava Air	Hava Air
İklim Sınıfı Climate Class	T	T
Voltaj Voltage	230-50/60 Hz 115-60 Hz	230-50 Hz 115-60 Hz
Maksimum Güç Maximum Power	800 W	590 W
Günlük Elektrik Tüketimi Daily Electric Consumption	16,5 kW	12,6 kW
Ürün Ağırlığı (kg) Product Weight (kg)	58 kg	58 kg
Ürün Ölçüleri (w*d*h) Product Dimension (w*d*h)	500*580*800	500*580*800
Ambalaj Ölçüleri (w*d*h) Packing Dimension (w*d*h)	560*640*965	560*640*965
Yükleme adedi (20 DC) Loading Quantities (20 DC)	72	72
Yükleme adedi (40 HC) Loading Quantities (40 HC)	144	144
Yükleme adedi (Optima Kamyon) Loading Quantities (Optima truck)	186	186



frozy



FR81

3.100 €

Soğutucu Gaz Refrigerant Gas	R404a	R290
Günlük Buz Yapma Kapasitesi (kg) Daily Production Capacity (kg)	79 kg	79 kg
Depolama Kapasitesi (kg) Storage Capacity (kg)	40 kg	40 kg
Buz Tipi Ice Type	Silindir Buz Hallow Ice	Silindir Buz Hallow Ice
Bir çevrimde buz miktarı (adet) Ice Capacity Per Cycle (unit)	56	56
Soğutma Sistemi Cooling System	Hava Air	Hava Air
İklim Sınıfı Climate Class	T	T
Voltaaj Voltage	230-50/60 Hz 115-60 Hz	230-50 Hz 115-60 Hz
Maksimum Güç Maximum Power	1100 W	640 W
Günlük Elektrik Tüketimi Daily Electric Consumption	18,0 kW	13,9 kW
Ürün Ağırlığı (kg) Product Weight (kg)	85 kg	85 kg
Ürün Ölçüleri (w*d*h) Product Dimension (w*d*h)	738*670*822	738*670*822
Ambalaj Ölçüleri (w*d*h) Packing Dimension (w*d*h)	800*670*995	800*670*995
Yükleme adedi (20 DC) Loading Quantities (20 DC)	46	46
Yükleme adedi (40 HC) Loading Quantities (40 HC)	102	102
Yükleme adedi (Optima Kamyon) Loading Quantities (Optima truck)	120	120



frozy



FR91

3.300 €

Soğutucu Gaz Refrigerant Gas	R404a	R290
Günlük Buz Yapma Kapasitesi (kg) Daily Production Capacity (kg)	90 kg	90 kg
Depolama Kapasitesi (kg) Storage Capacity (kg)	40 kg	40 kg
Buz Tipi Ice Type	Silindir Buz Hallow Ice	Silindir Buz Hallow Ice
Bir çevrimde buz miktarı (adet) Ice Capacity Per Cycle (unit)	64	64
Soğutma Sistemi Cooling System	Hava Air	Hava Air
İklim Sınıfı Climate Class	T	T
Voltaaj Voltage	230-50/60 Hz 115-60 Hz	230-50 Hz 115-60 Hz
Maksimum Güç Maximum Power	1.200 W	690 W
Günlük Elektrik Tüketimi Daily Electric Consumption	18,0 kW	14,8 kW
Ürün Ağırlığı (kg) Product Weight (kg)	97 kg	97 kg
Ürün Ölçüleri (w*d*h) Product Dimension (w*d*h)	738*600*822	738*600*822
Ambalaj Ölçüleri (w*d*h) Packing Dimension (w*d*h)	800*670*995	800*670*995
Yükleme adedi (20 DC) Loading Quantities (20 DC)	46	46
Yükleme adedi (40 HC) Loading Quantities (40 HC)	102	102
Yükleme adedi (Optima Kamyon) Loading Quantities (Optima truck)	120	120





HOME

frozy

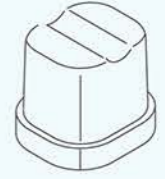

FR20

2.400 €

Soğutucu Gaz Refrigerant Gas	R404a	R290
Günlük Buz Yapma Kapasitesi (kg) Daily Production Capacity (kg)	22 kg	21 kg
Depolama Kapasitesi (kg) Storage Capacity (kg)	4 kg	4 kg
Buz Tipi Ice Type	Özel Buz Special Ice	Özel Buz Special Ice
Bir çevrimde buz miktarı (adet) Ice Capacity Per Cycle (unit)	18	18
Soğutma Sistemi Cooling System	Hava Air	Hava Air
İklim Sınıfı Climate Class	T	T
Voltaj Voltage	230-50/60 Hz 115-60 Hz	230-50 Hz 115-60 Hz
Maksimum Güç Maximum Power	400 W	300 W
Günlük Elektrik Tüketimi Daily Electric Consumption	6,7 kW	5,1 kW
Ürün Ağırlığı (kg) Product Weight (kg)	42 kg	42 kg
Ürün Ölçüleri (w*d*h) Product Dimension (w*d*h)	596*560*449	596*560*449
Ambalaj Ölçüleri (w*d*h) Packing Dimension (w*d*h)	656*620*509	656*620*509
Yükleme adedi (20 DC) Loading Quantities (20 DC)	210	210
Yükleme adedi (40 HC) Loading Quantities (40 HC)	420	420
Yükleme adedi (Optima Kamyon) Loading Quantities (Optima truck)	480	480





frozy
FISH

frozy



FR300

6.000 €

Soğutucu Gaz Refrigerant Gas	R404a	R452a
Günlük Buz Yapma Kapasitesi (kg) Daily Production Capacity (kg)	300 kg	300 kg
Buz Tipi Ice Type	Kırık Buz Flake Ice	Kırık Buz Flake Ice
Bir çevrimde buz miktarı Ice Capacity Per Cycle	-	-
Soğutma Sistemi Cooling System	Hava Air	Hava Air
İklim Sınıfı Climate Class	T	T
Voltaj Voltage	230 - 50/60 Hz 115 - 60 Hz	230 - 50/60 Hz 115 - 60 Hz
Maksimum Güç Maximum Power	2.500 W	2.500 W
Günlük Elektrik Tüketimi Daily Electric Consumption	61.5 kW	59.5 kW
Ürün Ağırlığı (kg) Product Weight (kg)	113 kg	113 kg
Ürün Ölçüleri (w*d*h) Product Dimension (w*d*h)	761*622*826	761*622*826
Ambalaj Ölçüleri (w*d*h) Packing Dimension (w*d*h)	830*690*1160	830*690*1160
Yükleme adedi (20 DC) Loading Quantities (20 DC)	69	69
Yükleme adedi (40 HC) Loading Quantities (40 HC)	144	144
Yükleme adedi (Optima Kamyon) Loading Quantities (Optima truck)	162	162



frozy



FR80

3.300 €

Soğutucu Gaz Refrigerant Gas	R404a	R290
Günlük Buz Yapma Kapasitesi (kg) Daily Production Capacity (kg)	80 kg	80 kg
Depolama Kapasitesi (kg) Storage Capacity (kg)	28 kg	28 kg
Buz Tipi Ice Type	Findık Buz Nugget Ice	Findık Buz Nugget Ice
Bir çevrimde buz miktarı Ice Capacity Per Cycle	-	-
Soğutma Sistemi Cooling System	Hava Air	Hava Air
İklim Sınıfı Climate Class	T	T
Voltaj Voltage	230-50/60 Hz 115-60 Hz	230-50/60 Hz 115-60 Hz
Maksimum Güç Maximum Power	650 W	610 W
Günlük Elektrik Tüketimi Daily Electric Consumption	14,6 kW	14,3 kW
Ürün Ağırlığı (kg) Product Weight (kg)	56 kg	56 kg
Ürün Ölçüleri (w*d*h) Product Dimension (w*d*h)	500*680*800	500*680*800
Ambalaj Ölçüleri (w*d*h) Packing Dimension (w*d*h)	560*640*965	560*640*965
Yükleme adedi (20 DC) Loading Quantities (20 DC)	72	72
Yükleme adedi (40 HC) Loading Quantities (40 HC)	144	144
Yükleme adedi (Optima Kamyon) Loading Quantities (Optima truck)	186	186



frozy



FR120

3.950 €

Soğutucu Gaz Refrigerant Gas	R404a	R290
Günlük Buz Yapma Kapasitesi (kg) Daily Production Capacity (kg)	120 kg	120 kg
Depolama Kapasitesi (kg) Storage Capacity (kg)	40 kg	40 kg
Buz Tipi Ice Type	Findık Buz Nugget Ice	Findık Buz Nugget Ice
Bir çevrimde buz miktarı Ice Capacity Per Cycle	-	-
Soğutma Sistemi Cooling System	Hava Air	Hava Air
İklim Sınıfı Climate Class	T	T
Voltaj Voltage	230-50/60 Hz 115-60 Hz	230-50/60 Hz 115-60 Hz
Maksimum Güç Maximum Power	1150 W	1050 W
Günlük Elektrik Tüketimi Daily Electric Consumption	17,6 kW	17,2 kW
Ürün Ağırlığı (kg) Product Weight (kg)	98 kg	98 kg
Ürün Ölçüleri (w*d*h) Product Dimension (w*d*h)	738*700*822	738*700*822
Ambalaj Ölçüleri (w*d*h) Packing Dimension (w*d*h)	800*670*995	800*670*995
Yükleme adedi (20 DC) Loading Quantities (20 DC)	46	46
Yükleme adedi (40 HC) Loading Quantities (40 HC)	102	102
Yükleme adedi (Optima Kamyon) Loading Quantities (Optima truck)	120	120



frozy

Üstün Özellikler | Superior Features



SERVİS DOSTU - SÖKÜLEBİLİR PANELLER
SERVICE FRIENDLY - REMOVABLE PANELS



Servis teknisyenin komponentlere kolayca ulaşımı için paneller kolayca sökülebilir.

The panels can be removed easily for easy access of service technician to components.



Üstün Özellikler | Superior Features



PÜSKÜRTMELİ SİSTEM
SPRAYER SYSTEM



Yatay konumdaki evaporatöre, sistem üzerinden alınan filtre edilmiş suyun püskürtülmesi ile kristal görünümlü buz üretme kabiliyeti.

Crystal looking ice production capability by spraying filtered water taken from the system to horizontal positioned evaporator.



KOLAY TEMİZLENEBİLİR YÜZEY
EASY CLEAN SURFACE



Inox 304 kalite paslanmaz gövde kalitesi ile kolay temizlenebilir yüzeyler.

Easy clean surfaces with inox 304 quality stainless steel trunk.



HAVA SOĞUTMALI SİSTEM
AIR COOLED SYSTEM

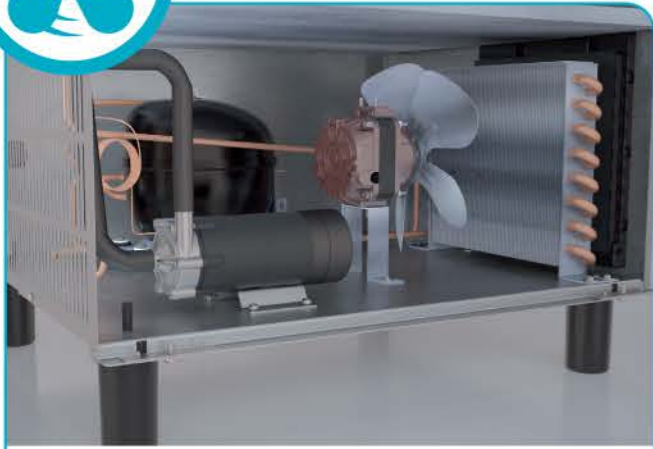

Kompresör ve evaporatörü sessizce soğutan fan teknolojisi.

The fan technology cooling the compressor and evaporator quietly.



Ag+ ANTİBAKTERİYEL BUZ SAKLAMA ALANI
ANTIBACTERIAL STORAGE AREA



Ag+ teknolojisi, buz saklama alanı içerisinde bakteri oluşumunu ve kötü kokuları engeller.

Ag+ technology prevents the formation of bacteria and unpleasant odor in ice storage area.

Üstün Özellikler | Superior Features



ELEKTRONİK KONTROL
ELECTRONIC CONTROL



Elektronik kontrol sistemi sayesinde su ve enerji tasarrufu sağlar.

The electronic control system saving water and energy.



GENİŞ BUZ STOKLAMA ALANI
LARGE ICE STORAGE SPACE



Yüksek buz saklama kapasitesi ile depolama sağlar.

It provides storage with the highest storage capacity.



T İKLİM SINIFI
T CLIMATE TYPE



Tropikal iklim sınıfı ile yaz - kış farkı yaratmadan yüksek performans ile çalışır.

It works with high performance without creating summer-winter difference with the tropical climate type,



KOLAY TEMİZLENEN HAVA FİLTRESİ
EASY CLEAN AIR FILTER



İki kapak arasındaki filtrenin kolayca temizlenmesi mümkündür.

It is possible to clean air filter between two lids easily.

Üstün Özellikler | Superior Features



EL TUTAMAKLI İZOLASYONLU KAPI
DOOR WITH HANDLE



İzolasyonlu entegre kapı, haznesindeki buzların uzun süre saklanmasına yardımcı olur.

Isolated Door With Integrated Handle, insulated integrated door helps to store ice in the storage for a longer time.



POLİÜRETAN İZOLASYONLU GÖVDE
POLYURETHANE ISOLATED BODY



Poliüretan izolasyonlu rijit gövdesi ile haznesindeki buzları daha uzun süre saklayabilir.

Polyurethane Isolated Body With a rigid body with polyurethane insulation, can store ice in the reservoir for longer.



OPSİYONEL TAHLİYE POMPALI SERVİS KİTİ
OPTIONAL SERVICE KIT WITH DRAIN PUMP



Ürün üzerine montaj imkânı bulunan opsiyonel tahliye pompası ile suyun tahliyesi güvenli şekilde yapılabilir.

Optional service kit with drain pump can be installed on the product, ensuring a safe water drainage.



MANYETİK POMPA İLE SESSİZ ÇALIŞMA
SILENT OPERATION WITH MAGNETIC PUMP



Manyetik su pompası ile sessizce çalışır.

It operates silently with magnetic water pump.

Üstün Özellikler | Superior Features



RAYLI KAPI
SLIDING LID



Kayar kapı mekanizmasıyla buz haznesine daha kolay erişim sağlar.

Easy access to the ice bin with sliding lid mechanism.



FONKSİYONEL DÜĞME
MULTIFUNCTIONAL BUTTON



Ön panel üzerinde bulunan temizlik butonu, ön panel sökülmeden buz makinesi temizlik moduna geçilir, bununla birlikte makinenin arıza durumunu ve deponun dolup dolmadığını gösterir.

Cleaning button on the front, switches the machine to cleaning mode without removing front panel, and alerts if there is a malfunction or if the ice bin is full.



ÜST SAC
TOP COVER



Üst sac, arka tarafta bulunan elle sökülebilen vidalar yardımıyla alet kullanmadan kolaylıkla sökülüp takılabilir.

Easy assembly and disassembly of the top cover with the help of two screws in the back without using any tools.



OPSİYONEL POTANSİYOMETRE
OPTIONAL POTENTIOMETER



Ön tarafta bulunan opsiyonel potansiyometre ile buzların büyüklüğü ayarlanabilir.

Optional potentiometer knob on the front provides adjusting the size of the ice cubes.

Buz Kullanım Bilgileri | Ice Usage Information

YEMEK SERVİSİ / FOOD SERVICE	Günlük yaklaşık buz kullanımı	Approximate ice usage per day
Restoran / Restaurant	0,3 kg kişi başı	0,3 kg per person
Kokteyl / Cocktail	0,8 kg kişi/ sandalye başı	0,8 kg person/seat
Salata bar / Salad Bar	350 kg/m ³	350 kg/m ³
Hızlı servis / Quick Service	150 ml, 200-300 ml içecek için	150 ml, 200-300 ml drink

KONAKLAMA / LODGING	Günlük yaklaşık buz kullanımı	Approximate ice usage per day
Müşteri Buzu / Guest ice	1,5 kg oda başı	1,5 kg per room
Restoran / Restaurant	0,4 kg kişi başı	0,4 kg per person
Kokteyl / Cocktail	0,8 kg kişi/ sandalye başı	0,8 kg per person/seat
Yiyecek / Catering	0,3 kg kişi başı	0,3 kişi per person

SAĞLIK / HEALTH	Günlük yaklaşık buz kullanımı	Approximate ice usage per day
Hasta buzu / Patient ice	3 kg yatak başı	3 kg per bed
Kafeterya / Cafeteria	0,3 kg kişi başı	0,3 kg per person

BÜFE & MARKET / BUFFET & MARKET	Günlük yaklaşık buz kullanımı	Approximate ice usage per day
Meşrubat / Beverage	180 ml, 350 ml içecek için	180 ml, per 350 ml drink
Soğuk tabak / Cold plate	%50 daha fazla buz kullanımı günlük	%50 more ice usage per day
Paket buz / Package ice	Günlük satılan buz kadar	Weight of ice sold per day



Kalite Belgeleri | Quality Certificates

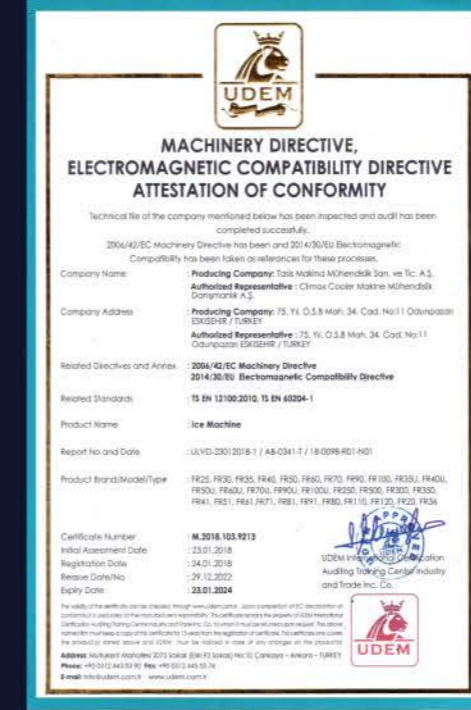



climaxcooler



FABRİKA - FACTORY

Organize Sanayi Bölgesi, 34. Cadde No:11

26110 Odunpazarı - ESKİŞEHİR / TÜRKİYE

☎ +90.222.236 82 20

☎ +90.222.236 82 21

✉ marketing@frozy.com.tr

✉ sales@frozy.com.tr



www.frozy.com.tr